

# MBOX

SHOWER ENCLOSURES

Introducing  
Wetrooms in  
Colour Finishes



*Matt Black Wetroom*



*Brushed Bronze Wetroom*



*Brushed Brass Wetroom*



# THIS RANGE NOW HAS 53 DIFFERENT SIZE OPTIONS IN ADDITION TOO TRAY OPTIONS TO SUIT EACH SPACE!

Product	Size	Door	Touchstone and Touchstone-SR Trays
Sliding Door	1000***	√	√
	1100	√	√
	1200***	√	√
	1300	√	√
	1400***	√	√
	1500	√	√
	1600	√	√
***Low Level Access Sizes Now Available	1700***	√	√
1 Door Quadrant	800	√	√
	900	√	√
	1000	√	√*
1 Door Offset Quadrant	1000 x 800	√	√
	1200 x 800	√	√
	1200 x 900	√	√
2 Door Quadrant	800	√	√
	900	√	√
2 Door Offset Quadrant	900 x 760	√	√*
	900 x 800	√	-
	1000 x 800	√	√
	1200 x 800	√	√
	1200 x 900	√	√
Pivot Door	700	√	√
	760	√	√
	800	√	√
	900	√	√
	1000	√	√
Bifold Door	700	√	√
	760	√	√
	800	√	√
	900	√	√
	1000	√	√
Corner Door	760 x 760	√	√
	800 x 800	√	√
	900 x 900	√	√
Side Panels	700	√	√
	760	√	√
	800	√	√
	900	√	√
	1000	√	√
Inline Panels	150	√	√
	210	√	√

Loft Sizes 1800mm high	Size	Door	Touchstone and Touchstone-SR Trays
Sliding Door	1200	√	√
2 Door Quadrant	800	√	√
	900	√	√
Bifold Door	760	√	√
	800	√	√
	900	√	√
Side Panels	800	√	√
	900	√	√

Easy-Fit Bath Screens	
Product	Size
Single Curved	800 x 1500
Single Squared	800 x 1500
2 Panel Curved	1150 x 1500
2 Panel Folding Curved	1150 x 1500
2 Panel Folding Squared	900 x 1500
2 Panel Hinged	900 x 1500



Our slip resistant shower trays are now available with MBOX.

\*Tray sizes available in our MStone range

# Contents

## *Collections*

### MBOX

Sliding Door .....	6
Sliding door Low Access .....	7
1 Door Quadrant .....	8
2 Door Quadrant .....	9
Pivot Door .....	10
Bifold Door .....	11
Corner Door .....	12
Inline Panels .....	13

### The MERLYN Wetroom Collection

8mm Wetrooms .....	14
--------------------	----

Bath Screens .....	16
--------------------	----

### MERLYN Trays

Touchstone Trays .....	20
Slip Resistant Trays .....	22

## *Technical Information*

Product Information .....	24
---------------------------	----











# MBOX

SHOWER ENCLOSURES

Extensive Range - 53 sizes available

The MBOX range delivers stylish, quality products with additional features and benefits including heights of 1800mm and 1900mm and comes with pre-assembled fixtures making it easier to fit.

MBOX offers loft height sizes (1800mm) in Sliding Doors, Bifold Doors, Two Door Quadrants and Side Panels. These loft sizes are ideal for low ceilings, making the most out of the space in your bathroom.

### Unique Easy Fit System

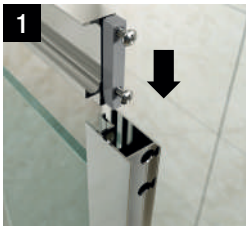

Align the horizontal and vertical profiles together.



Slot the horizontal profile and screws into upright using guide channel until flush.



Secure screws into position using dedicated access holes.

### Double Rollers

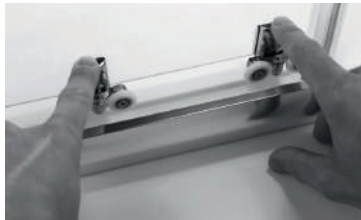

All rollers on MBOX products are double quick release for easy cleaning.

### Inline Panels



MBOX offers Inline Panels that can be used in any space from 650mm to 1900mm.

### Loft sizes



MBOX offers 3 reduced height doors. Perfect for converted loft spaces. Available in sliding door, bifold door, side panels and two door quadrant.

# Sliding Door

## Features

- » Height 1900mm
- » 6mm toughened safety glass
- » 10 year guarantee
- » Reversible
- » Magnetic seals
- » Easy to install
- » Mershield™ protected glass
- » Chrome designer handle
- » UKCA & CE Approved
- » 20mm adjustment per wall profile
- » Loft height available
- » Optional cover strips available - see pg 12

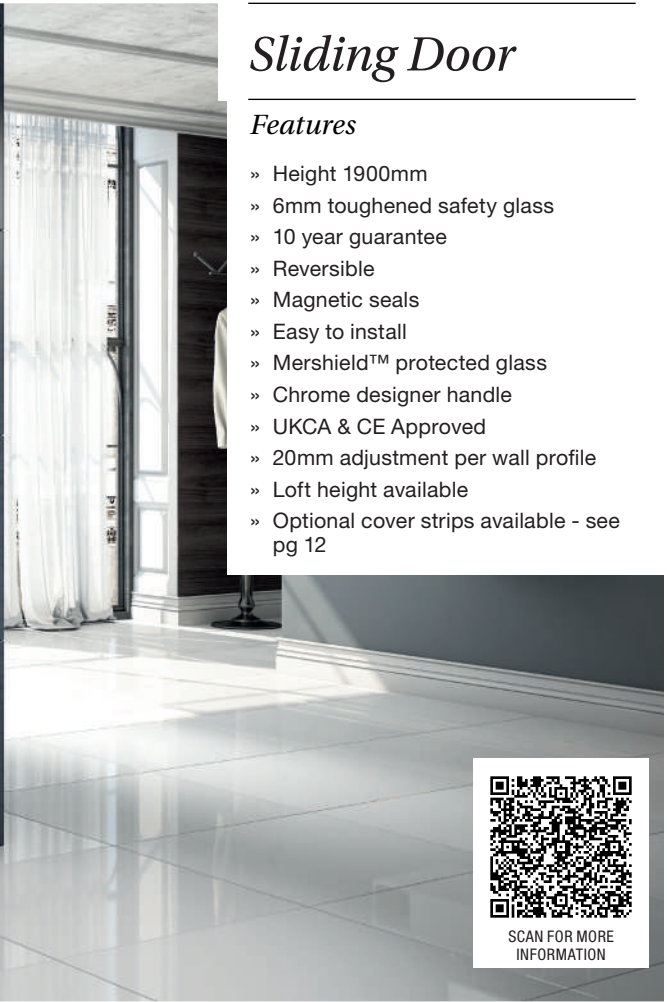

Sliding door with Side Panel / Shown Right Hand

### Sliding Door in Recess & for use with Side Panel

Size	Adjustment	Code	Price £ Exc. VAT	Price £ Inc. VAT
1000	950 - 990	MBS1000	405.25	486.30
1100	1050 - 1090	MBS1100	405.25	486.30
1200	1150 - 1190	MBS1200	405.25	486.30
1300	1250 - 1290	MBS1300	477.79	573.35
1400	1350 - 1390	MBS1400	477.79	573.35
1500	1450 - 1490	MBS1500	492.39	590.87
1600	1550 - 1590	MBS1600	506.21	607.45
1700	1650 - 1690	MBS1700	521.43	625.72

Please Note: Cover strips do not come as standard and need to be ordered separately if required - see page 12

### Optional Side Panel

Size	Adjustment	Code	Price £ Exc. VAT	Price £ Inc. VAT
700	670 - 690	MBSP700	224.08	268.90
760	730 - 750	MBSP760	224.08	268.90
800	770 - 790	MBSP800	224.08	268.90
900	870 - 890	MBSP900	238.06	285.67
1000	970 - 990	MBSP1000	294.43	353.31

### Optional Inline Panel

Size	Adjustment	Code	Price £ Exc. VAT	Price £ Inc. VAT
150	130 - 150	MBN150	195.82	234.99
210	190 - 210	MBN210	195.82	234.99

For more information on Inline Panels see page 13

## Loft Heights

### Loft Sliding Door (Height 1800mm)

Size	Adjustment	Code	Price £ Exc. VAT	Price £ Inc. VAT
1200	1150 - 1190	MBS1200/1800	486.85	584.22

### Loft Side Panel (Height 1800mm)

Size	Adjustment	Code	Price £ Exc. VAT	Price £ Inc. VAT
800	770 - 790	MBSP800/1800	269.07	322.89
900	870 - 890	MBSP900/1800	285.97	343.16

## Technical drawing

Size	X	B
1000	367	430
1100	417	480
1200	467	530
1300	517	580
1400	567	630
1500	567	730
1600	567	830
1700	567	930

X: Door Opening  
B = Fixed Panel  
D = Side Panel

Sliding Door in Recess



Sliding Door with Side Panel

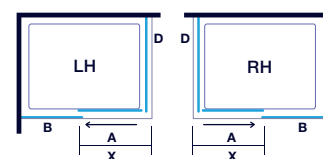

# Low Level Access Sliding Door



Low Level Access Sliding door with Side Panel / Shown Right Hand

## Features

- » Height 1900mm
  - » 6mm toughened safety glass
  - » 10 year guarantee
  - » No bottom rollers
  - » Bottom glide system
  - » Easy-fit system
  - » Mershield™ protected glass
  - » Handed
  - » UKCA & CE Approved
  - » Push button door release for easy clean
  - » Adjustable fin seal for increased water retention
  - » Optional cover strips available - see pg 12
  - » Threshold strip just 6mm high
- Note: Products are left or right handed due to bottom guide and no bottom profile.



SCAN FOR MORE INFORMATION

## Low Level Access Sliding Door

Size	Adjustment	Code	Price £ Exc. VAT	Price £ Inc. VAT
1000	950 - 990	MBLA1000L	452.46	542.95
1000	950 - 990	MBLA1000R	452.46	542.95
1200	1150 - 1190	MBLA1200L	472.12	566.55
1200	1150 - 1190	MBLA1200R	472.12	566.55
1400	1350 - 1390	MBLA1400L	556.66	668.00
1400	1350 - 1390	MBLA1400R	556.66	668.00
1700	1650 - 1690	MBLA1700L	607.49	728.99
1700	1650 - 1690	MBLA1700R	607.49	728.99

Please Note: Cover strips do not come as standard and need to be ordered separately if required - see page 12



Low Level Access Sliding door in recess

## Optional Side Panel

Size	Adjustment	Code	Price £ Exc. VAT	Price £ Inc. VAT
700	670 - 690	MBSP700	224.08	268.90
760	730 - 750	MBSP760	224.08	268.90
800	770 - 790	MBSP800	224.08	268.90
900	870 - 890	MBSP900	238.06	285.67
1000	970 - 990	MBSP1000	294.43	353.31

## Technical drawing

Size	X	B
1000	365	435
1200	465	535
1400	565	635
1700	565	935

Sliding Door with Side Panel

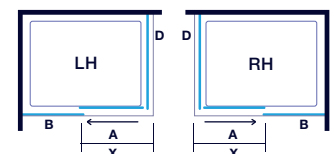

X: Door Opening  
B = Fixed Panel  
D = Side Panel

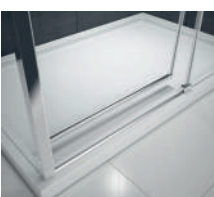

Push Release

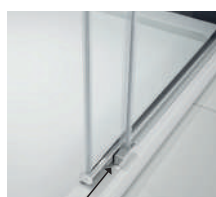

Bottom Glide System

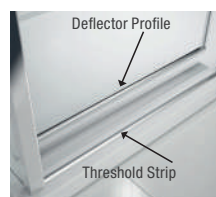

Slimline Threshold





# 1 Door Quadrant

## Features

- » Height 1900mm
- » 6mm toughened safety glass
- » 10 year guarantee
- » Reversible
- » Easy to install
- » Quick release double rollers for easy clean
- » Mershield™ protected glass
- » Chrome designer handle
- » UKCA & CE Approved
- » 20mm adjustment per wall profile
- » Optional cover strips available - see pg 12



1 Door Quadrant / Shown Left Hand

### 1 Door Quadrant

Size	Adjustment	Code	Price £ Exc. VAT	Price £ Inc. VAT
800 x 800	770 - 790	MB1Q800	533.90	640.68
900 x 900	870 - 890	MB1Q900	533.90	640.68
1000 x 1000	970 - 990	MB1Q1000	632.51	759.01

### 1 Door Offset Quadrant

900 x 760	870 - 890 / 730 - 750	MB1Q976	591.66	709.99
1000 x 800	970 - 990 / 770 - 790	MB1Q1080	625.47	750.57
1200 x 800	1170 - 1190 / 770 - 790	MB1Q1280	646.59	775.91
1200 x 900	1170 - 1190 / 870 - 890	MB1Q1290	671.96	806.35

Please Note: Cover strips do not come as standard and need to be ordered separately if required - see page 12



1 Door Offset Quadrant / Shown Left Hand

## Technical drawing

Size	X	B	C
800 x 800	422	490	235
900 x 760	310	448	550
900 x 900	476	529	335
1000 x 800	422	490	435
1000 x 1000	476	629	435
1200 x 800	424	490	635
1200 x 900	475	529	635

B: Straight Panel  
C: Curved Panel  
X: Door Opening

1 Door Quadrant

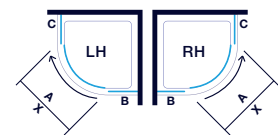

1 Door Offset Quadrant

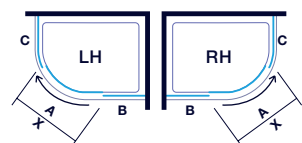





## 2 Door Quadrant

### Features

- » Height 1900mm
- » 6mm toughened safety glass
- » 10 year guarantee
- » Reversible
- » Magnetic seals
- » Easy to install
- » Quick release double rollers for easy clean
- » Mershield™ protected glass
- » Chrome designer handle
- » UKCA & CE Approved
- » 20mm adjustment per wall profile
- » Loft height available
- » Optional cover strips available - see pg 12



2 Door Quadrant

2 Door Quadrant				
Size	Adjustment	Code	Price £ Exc. VAT	Price £ Inc. VAT
800 x 800	770 - 790	MB2Q800	393.02	471.62
900 x 900	870 - 890	MB2Q900	393.02	471.62

2 Door Offset Quadrant				
Size	Adjustment	Code	Price £ Exc. VAT	Price £ Inc. VAT
900 x 760	870 - 890 / 730 - 750	MB2Q9076	445.16	534.19
900 x 800	870 - 890 / 770 - 790	MB2Q8090	471.91	566.29
1000 x 800	970 - 990 / 770 - 790	MB2Q1080	476.15	571.38
1200 x 800	1170 - 1190 / 770 - 790	MB2Q1280	501.51	601.81
1200 x 900	1170 - 1190 / 870 - 890	MB2Q1290	524.04	628.85

Please Note: Cover strips do not come as standard and need to be ordered separately if required - see page 12

## Loft Heights

Loft 2 Door Quadrant (Height 1800mm)				
Size	Adjustment	Code	Price £ Exc. VAT	Price £ Inc. VAT
800 x 800	770 - 790	MB2Q800/1800	471.91	566.29
900 x 900	870 - 890	MB2Q900/1800	471.91	566.29



2 Door Offset Quadrant

### Technical drawing

Size	X	B	C
800 x 800	410	235	235
900 x 760	432	335	195
900 x 900	524	335	335
900 x 800	473	335	235
1000 x 800	465	435	235
1200 x 800	465	635	235
1200 x 900	524	635	335

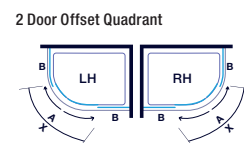
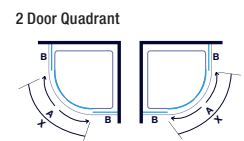

B: Straight Panel X: Door Opening  
C: Curved Panel

# Pivot Door

## Features

- » Height 1900mm
- » 6mm toughened safety glass
- » 10 year guarantee
- » Reversible
- » Magnetic seals
- » Ideal for restricted spaces
- » Mershield™ protected glass
- » Chrome designer handle
- » UKCA & CE Approved
- » 20mm adjustment per wall profile
- » Optional cover strips available - see pg 12



Pivot Door / Shown Right Hand



SCAN FOR MORE INFORMATION

### Pivot Door

Size	Adjustment	Code	Price £ Exc. VAT	Price £ Inc. VAT
700	650 - 690	MBP700	320.89	385.07
760	710 - 750	MBP760	337.47	404.96
800	750 - 790	MBP800	337.47	404.96
900	850 - 890	MBP900	360.99	433.19
1000	950 - 990	MBP1000	383.11	459.73

Please Note: Cover strips do not come as standard and need to be ordered separately if required - see page 12

### Optional Side Panel

Size	Adjustment	Code	Price £ Exc. VAT	Price £ Inc. VAT
700	670 - 690	MBSP700	224.08	268.90
760	730 - 750	MBSP760	224.08	268.90
800	770 - 790	MBSP800	224.08	268.90
900	870 - 890	MBSP900	238.06	285.67
1000	970 - 990	MBSP1000	294.43	353.31

### Optional Inline Panel

Size	Adjustment	Code	Price £ Exc. VAT	Price £ Inc. VAT
150	130 - 150	MBN150	195.82	234.99
210	190 - 210	MBN210	195.82	234.99

Measurements above are for both Pivot Door with Side Panel and in Recess. Inline Panels above are for both Pivot Door and Bifold Door options. For more information on Inline Panels see page 13

## Technical drawing

Size	X	Y
700	451	433
760	511	493
800	551	533
900	600	583
1000	671	653

Pivot Door in Recess

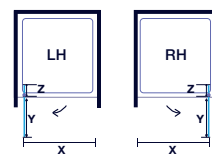

Pivot Door with Side Panel

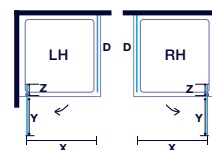

D: Side Panel  
Y: Outside Door Swing  
X: Door Opening  
Z: Inside Door Swing

# Bifold Door

## Features

- » Height 1900mm
- » 4mm toughened safety glass
- » 10 year guarantee
- » Reversible
- » Magnetic seals
- » MerShield™ protected glass
- » Chrome designer handle
- » Loft height available
- » UKCA & CE Approved
- » 20mm adjustment per wall profile
- » Optional cover strips available - see pg 12



Bifold Door / Shown Right Hand

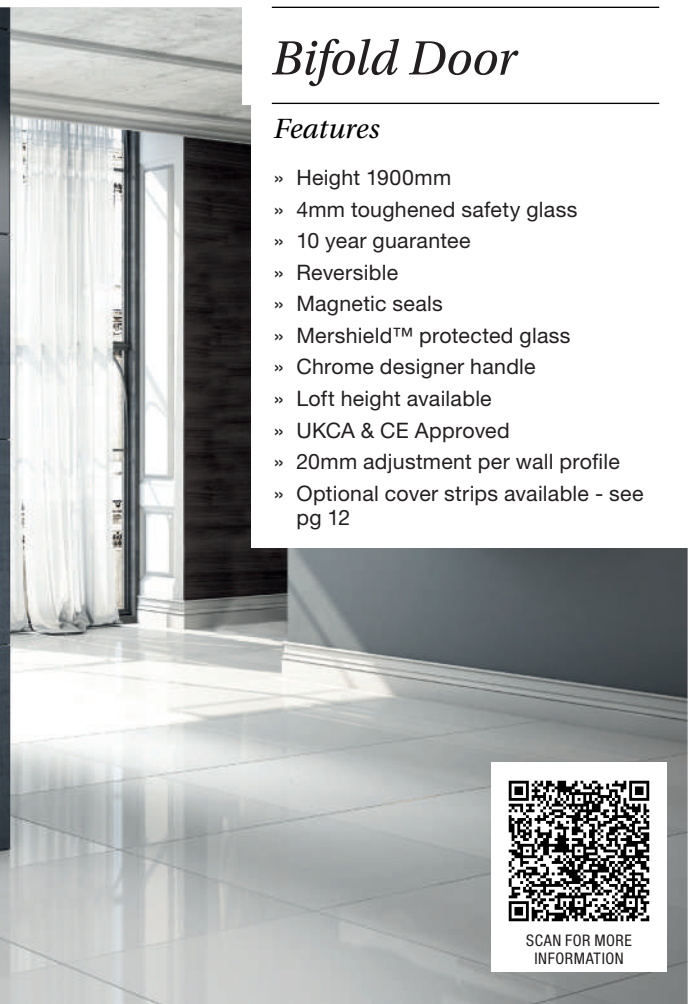

SCAN FOR MORE INFORMATION

### Bifold Door

Size	Adjustment	Code	Price £ Exc. VAT	Price £ Inc. VAT
700	650 - 690	MBB700	383.17	459.81
760	710 - 750	MBB760	383.17	459.81
800	750 - 790	MBB800	383.17	459.81
900	850 - 890	MBB900	402.89	483.46
1000	950 - 990	MBB1000	436.69	524.03

Please Note: Cover strips do not come as standard and need to be ordered separately if required - see page 12

### Optional Side Panel

Size	Adjustment	Code	Price £ Exc. VAT	Price £ Inc. VAT
700	670 - 690	MBSP700	224.08	268.90
760	730 - 750	MBSP760	224.08	268.90
800	770 - 790	MBSP800	224.08	268.90
900	870 - 890	MBSP900	238.06	285.67
1000	970 - 990	MBSP1000	294.43	353.31

### Optional Inline Panel

Size	Adjustment	Code	Price £ Exc. VAT	Price £ Inc. VAT
150	130 - 150	MBN150	195.82	234.99
210	190 - 210	MBN210	195.82	234.99

Measurements above are for both Bifold Door with Side Panel and in Recess. Inline Panels above are for both Pivot Door and Bifold Door options. For more information on Inline Panels see page 13

## Loft Heights

### Loft Bifold Door (Height 1800mm)

Size	Adjustment	Code	Price £ Exc. VAT	Price £ Inc. VAT
760	710 - 750	MBB760/1800	478.97	574.77
800	750 - 790	MBB800/1800	478.97	574.77
900	850 - 890	MBB900/1800	503.60	604.32



SCAN FOR LOFT HEIGHTS

### Loft Side Panel (Height 1800mm)

Size	Adjustment	Code	Price £ Exc. VAT	Price £ Inc. VAT
800	770 - 790	MBSP800/1800	269.07	322.89
900	870 - 890	MBSP900/1800	285.97	343.16

Measurements above are for both Bifold Door with a Side panel and in a Recess. Please Note: Cover strips do not come as standard and need to be ordered separately if required - see page 12

## Technical drawing

Size	X	Z
700	370	284
760	430	315
800	470	336
900	570	387
1000	670	438

### Bifold Door in Recess

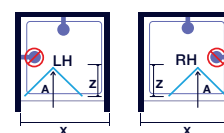

### Bifold Door with Side Panel

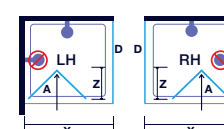

A: Moving Panel  
 D: Side Panel  
 X: Door Opening  
 Z: Width of panel when folded





## Corner Door

### Features

- » Height 1900mm
- » 6mm toughened safety glass
- » 10 year guarantee
- » Reversible
- » Magnetic seals
- » Easy to install
- » Mershield™ protected glass
- » Chrome designer handle
- » UKCA & CE Approved
- » 20mm adjustment per wall profile
- » Optional cover strips available - see pg 12

Corner Door

### Corner Door

Size	Adjustment	Code	Price £ Exc. VAT	Price £ Inc. VAT
760 x 760	730 - 750	MBC760	560.67	672.80
800 x 800	770 - 790	MBC800	590.24	708.29
900 x 900	870 - 890	MBC900	633.92	760.70

Please Note: Cover strips do not come as standard and need to be ordered separately if required - see page 12

### Technical drawing

Size	X	B
760 x 760	345	310
800 x 800	375	330
900 x 900	444	380

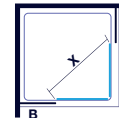

X: Door Opening  
B: Fixed Panel

## MBOX Cover Strips

### Standard Panel Cover Strip Pack (2 Pieces)

Size (WxH)	Code	Price £ Ex. VAT	Price £ Inc. VAT
1900	MBWPKIT	69.03	82.83

### Side Panel Cover Strip Pack (1 Piece)

Size (WxH)	Code	Price £ Ex. VAT	Price £ Inc. VAT
1900	MBSPKIT	54.95	65.93

### Inline Panel Cover Strip Pack (1 Piece)

Size (WxH)	Code	Price £ Ex. VAT	Price £ Inc. VAT
1900	MBNKIT	54.95	65.93

Please note: Cover strips do not come as standard and need to be ordered separately if required.

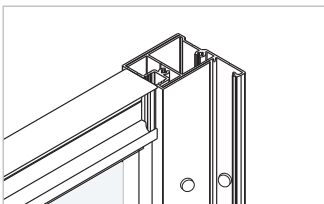

Without cover strip - chrome screw cover caps

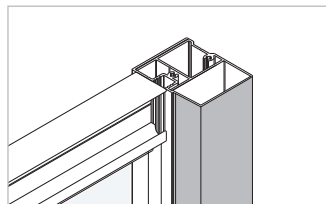

With cover strip - conceals all fixings

# Inline Panels

MBOX also offers you additional Inline Panel options. A great solution for spaces which don't suit standard size enclosures. The two Inline Panel sizes each combined with our existing Sliding, Bifold and Pivot Doors, can make an enclosure to fit any space from 650mm to 1900mm wide.

Size	Code	Price £ Ex. VAT	Price £ Inc. VAT
150	MBN150	195.82	234.99
210	MBN210	195.82	234.99



*Sliding door with inline panel*



*Pivot door with inline panel*



*Bifold door with inline panel*

## Sliding Door - with inline panel

Code	Door Size	Door Adjustment	Inline Panels / Profile	Final Adjustment
MBS1000	1000	950-990	-	950-990
			EXT Profile	970-1010
MBS1000	1000	950-990	3 EXT Profile	990-1050
MBS1100	1100	1050-1090	-	1050-1090
			EXT Profile	1070-1110
MBS1000	1000	950-990	150 Inline	1080-1140
			210 Inline	1140-1200
MBS1100	1100	1050-1090	150 Inline	1180-1240
			210 Inline	1240-1300
MBS1200	1200	1150-1190	150 Inline	1280-1340
MBS1400	1400	1350-1390	-	1350-1390
			EXT Profile	1370-1410
MBS1100	1100	1050-1090	150+210 Inlines	1370-1450
MBS1500	1500	1450-1490	-	1450-1490
			EXT Profile	1470-1510
MBS1400	1400	1350-1390	150 Inline	1480-1540
			210 Inline	1540-1600
MBS1500	1500	1450-1490	150 Inline	1580-1640
			210 Inline	1640-1700
MBS1600	1600	1550-1590	150 Inline	1680-1740
			210 Inline	1740-1800
MBS1700	1700	1650-1690	150 Inline	1780-1840
			210 Inline	1840-1900

## Pivot Door - with inline panel

Code	Door Size	Door Adjustment	Inline Panels / Profile	Final Adjustment
MBP700	700	650-690	-	650-690
			EXT Profile	670-710
MBP760	760	710-750	-	710-750
MBP800	800	750-790	-	750-790
			EXT Profile	770-810
MBP700	700	650-690	150 Inline	780-840
			210 Inline	840-900
MBP760	760	710-750	210 Inline	900-960
MBP1000	1000	950-990	EXT profile	970-1010
MBP900	900	850-890	150 Inline	980-1040
			210 Inline	1040-1100
MBP1000	1000	950-990	150 Inline	1080-1140
			210 Inline	1140-1200

## Bifold Door - with inline panel

Code	Door Size	Door Adjustment	Inline Panels / Profile	Final Adjustment
MBB700	700	650-690	-	650-690
			EXT Profile	670-710
MBB760	760	710-750	-	710-750
MBB800	800	750-790	-	750-790
			EXT Profile	770-810
MBB700	700	650-690	150 Inline	780-840
			210 Inline	840-900
MBB760	760	710-750	210 Inline	900-960
MBB1000	1000	950-990	EXT profile	970-1010
MBB900	900	850-890	150 Inline	980-1040
			210 Inline	1040-1100
MBB1000	1000	950-990	150 Inline	1100-1140
			210 Inline	1140-1200



Wetroom Panel with FLuted Glass / Shown in Brushed Brass

## 8mm Wetroom Panels

Choose from a variety of shapes and sizes with our 8mm Wetroom Panels. Our modular system allows seamless customization for any wetroom space.

### features

- » Height 2015mm (including rail)
- » Reversible
- » All panels from 700mm & above come with a 1000mm stabilising bar
- » 3m support post can be retro-fitted to glass thicknesses of 8mm
- » Suitable for recess or corner situation
- » Swivel panel can be retrofitted to any 8mm shower wall
- » Corner profile option available
- » Strong & sturdy construction

Wetroom Panels Fluted Glass						
Ref	Size	Product	Code	Colour Code	Price £ Exc. VAT	Price £ Inc. VAT
E	700	675-690	8WFL70	add <b>MB / BBR</b> or <b>BBZ</b>	656.67	788.00
G	800	775-790	8WFL80	add <b>MB / BBR</b> or <b>BBZ</b>	665.83	799.00
H	900	875-890	8WFL90	add <b>MB / BBR</b> or <b>BBZ</b>	673.33	808.00
I	1000	975-990	8WFL10	add <b>MB / BBR</b> or <b>BBZ</b>	722.50	867.00
J	1100	1075-1090	8WFL11	add <b>MB / BBR</b> or <b>BBZ</b>	765.00	918.00
K	1200	1175-1190	8WFL12	add <b>MB / BBR</b> or <b>BBZ</b>	770.00	924.00

### Technical drawing



Please Note: Panels E-H are the only panels that can be used as an end panel. All panels 700mm and above come with 1000mm straight bracing bar. Sizes 700mm -900mm come with T-shape bracket to join two bracing bars.

### Add Colour; Express yourself

When ordering your wetroom panel, please add the desired colour code to the end of the standard chrome code.

**Example:** 8WFL12 is the standard chrome code add **MB** for Matt Black, **BBR** for Brushed Brass or **BBZ** for Brushed Bronze.

**E.G. 8W12FLMB = 8W12FL Matt Black.**

**MB = Matt Black**

**BBR = Brushed Brass**

**BBZ = Brushed Bronze**





**How it works:** To make up a Walk In wetroom to fit on a 1200mm x 800mm tray or area floor space. You pick panel A (700mm) and panel B (800mm), this also includes the recommended 500mm minimum opening for the Walk In.

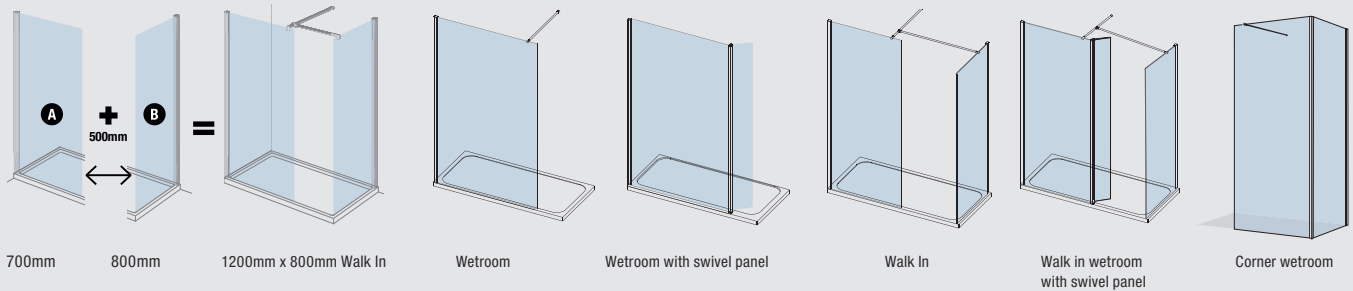

#### Wetroom Panels Chrome

Ref	Size	Adjustment	Code	Price £ Exc. VAT	Price £ Inc. VAT
A	300	275-290	8W30	240.00	288.00
B	400	375-390	8W40	248.33	298.00
C	500	475-490	8W50	256.67	308.00
D	600	575-590	8W60	270.00	324.00
E	700	675-690	8W70	290.00	348.00
F	760	735-750	8W76	293.33	352.00
G	800	775-790	8W80	295.83	355.00
H	900	875-890	8W90	300.00	360.00
I	1000	975-990	8W10	329.17	395.00
J	1100	1075-1090	8W11	354.17	425.00
K	1200	1175-1190	8W12	356.67	428.00
L	1400	1375-1390	8W14	410.83	493.00
M	1600	1575-1590	8W16	465.00	558.00

Please Note: Panels A-H are the only panels that can be used as an end panel. Panels A-D do not come with a stabilising bar / Panels E-M come with stabilising bar. All panels 700mm and above come with 1000mm straight bracing bar. Sizes 700mm-900mm come with T-shape bracket to join two bracing bars.

#### Wetroom Panels Colour

Ref	Size	Adjustment	Code	Colour Code	Price £ Exc. VAT	Price £ Inc. VAT
A	300	275-290	8W30	add <b>MB</b> / <b>BBR</b> or <b>BBZ</b>	335.83	403.00
B	400	375-390	8W40	add <b>MB</b> / <b>BBR</b> or <b>BBZ</b>	344.17	413.00
C	500	475-490	8W50	add <b>MB</b> / <b>BBR</b> or <b>BBZ</b>	352.50	423.00
D	600	575-590	8W60	add <b>MB</b> / <b>BBR</b> or <b>BBZ</b>	365.83	439.00
E	700	675-690	8W70	add <b>MB</b> / <b>BBR</b> or <b>BBZ</b>	385.83	463.00
F	760	735-750	8W76	add <b>MB</b> / <b>BBR</b> or <b>BBZ</b>	389.17	467.00
G	800	775-790	8W80	add <b>MB</b> / <b>BBR</b> or <b>BBZ</b>	391.67	470.00
H	900	875-890	8W90	add <b>MB</b> / <b>BBR</b> or <b>BBZ</b>	395.83	475.00
I	1000	975-990	8W10	add <b>MB</b> / <b>BBR</b> or <b>BBZ</b>	425.00	510.00
J	1100	1075-1090	8W11	add <b>MB</b> / <b>BBR</b> or <b>BBZ</b>	450.00	540.00
K	1200	1175-1190	8W12	add <b>MB</b> / <b>BBR</b> or <b>BBZ</b>	452.50	543.00
L	1400	1375-1390	8W14	add <b>MB</b> / <b>BBR</b> or <b>BBZ</b>	506.67	608.00
M	1600	1575-1590	8W16	add <b>MB</b> / <b>BBR</b> or <b>BBZ</b>	560.83	673.00

Please Note: Panels A-H are the only panels that can be used as an end panel. Panels A-D do not come with a stabilising bar / Panels E-M come with stabilising bar. All panels 700mm and above come with 1000mm straight bracing bar. Sizes 700mm -900mm come with T-shape bracket to join two bracing bars.

#### Additional Options Chrome

Ref	Size	Product	Code	Price £ Exc. VAT	Price £ Inc. VAT
N	200	Swivel panel	8WSV20	162.50	195.00
O	300	Swivel panel	8WSV30	170.83	205.00
P	400	Swivel panel	8WSV40	183.33	220.00
Q	3000	Vertical ceiling post	3MCP	133.33	160.00
R	2000	Corner post profile	8WCR	62.50	75.00
S	1000	Round bracing bar	N126CH	133.33	160.00
T	1500	Round bracing bar	N127CH	162.50	195.00
U	-	Round T- piece bracket	A04S0010	45.83	55.00
V	350	Angled stabilising bar	SP08SCU12320	95.83	115.00
W	400	Vertical ceiling bracing bar	CBB440	108.33	130.00

Note: 3m vertical ceiling post can be retro-fitted to glass thickness of 8mm. Corner profile post is suitable for L-shape corner situations only & recommend using a stabilising bar for all size panels with this configuration. Corner Profile must be used with two Wetroom Panels. Round bracing bar can be retrofitted to 8mm glass.

#### Additional Options Colour

Ref	Size	Product	Code	Colour Code	Price £ Exc. VAT	Price £ Inc. VAT
O	300	Swivel panel	8WSV30	add <b>MB</b> / <b>BBR</b> or <b>BBZ</b>	237.50	285.00
Q	3000	Vertical ceiling post	3MCP	add <b>MB</b> / <b>BBR</b> or <b>BBZ</b>	175.00	210.00
R	2000	Corner post profile	8WCR	add <b>MB</b> / <b>BBR</b> or <b>BBZ</b>	104.17	125.00
S	1000	Round bracing bar	N126	add <b>MB</b> / <b>BBR</b> or <b>BBZ</b>	175.00	210.00
T	1500	Round bracing bar	N127	add <b>MB</b> / <b>BBR</b> or <b>BBZ</b>	204.17	245.00
U	-	Round T- piece bracket	A04S0010	add <b>B</b> / <b>BBR</b> or <b>BBZ</b>	75.00	90.00
W	400	Vertical ceiling bracing bar	CBB440	add <b>MB</b> / <b>BBR</b> or <b>BBZ</b>	125.00	150.00

Note: 3m vertical ceiling post can be retro-fitted to glass thickness of 8mm. Corner profile post is suitable for L-shape corner situations only & recommend using a stabilising bar for all size panels with this configuration. Corner Profile must be used with two Wetroom Panels.

#### Tray Accessories

Size	Add-On	Code	Price £ Exc. VAT	Price £ Inc. VAT
-	White Waste Cap	DWASCAPWHT	17.12	20.54

Waste Cap for Touchstone trays comes in standard chrome. Please use code above for white waste cap.

### Add Colour; Express yourself

When ordering your wetroom panel, please add the desired colour code to the end of the standard chrome code.

**Example:** 8W12 is the standard chrome code add **MB** for Matt Black, **BBR** for Brushed Brass or **BBZ** for Brushed Bronze.

**E.G. 8W12MB = 8W12 Matt Black.**

**MB** = Matt Black

**BBR** = Brushed Brass

**BBZ** = Brushed Bronze



# MERLYN *bath screens*

## *some unique features*

### MERLYN **EASY-FIT**

## Replace your Bath Screen with Ease

An innovative way to replace your bath screen without the need to re-drill the wall. Simply connect your easy-fit to the existing holes in the wall and install your new bath screen.



**NO DRILLING**



### Fitting Steps

Easy-Fit profile



**01.**  
Remove the old profile

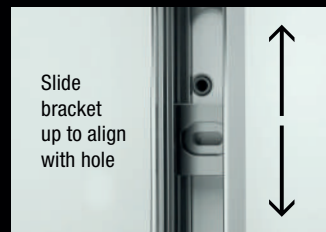

**02.**  
Position the EASY-fit profile on the wall

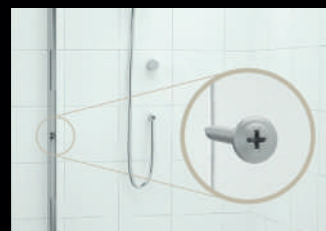

**03.**  
Adjust the brackets to align to the existing holes and fix in position



## HydraSEAL

## Exclusive to MERLYN Bath Screens

HydraSEAL acts as an extra barrier, sealing the gap between the seal and the pivot point where water can usually escape.

It contains a high density foam that compresses onto the bath screen to form a tight seal and restricts water escaping from this problem area.

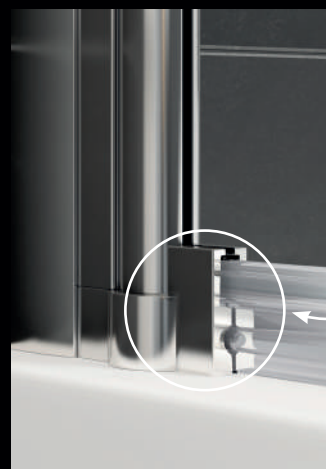

HydraSEAL creates a barrier to restrict leaking!

**EASY FIT** and **HydraSEAL** are Available with following Bath Screens: **MB1 / MB2 / MB3 / MB3A / MB3B / MB3C**

**MB0**  
Bathscreen

SCAN FOR MORE INFORMATION

1500 MM  
HEIGHT  
STANDARD RANGE

6 MM  
GLASS  
THICKNESS

LIFETIME  
GUARANTEE

**Single Square Fixed Panel**

Size	Code	Panel	Product Adjustment	Price £ Exc. VAT	Price £ Inc. VAT
800 x 1500	MB0	1	785-800	159.92	191.91

*Features*

- » Fixed frameless screen
- » 6mm toughened safety glass
- » Reversible
- » Lifetime guarantee

**MB1**  
Bathscreen

SCAN FOR MORE INFORMATION

1500 MM  
HEIGHT  
STANDARD RANGE

6 MM  
GLASS  
THICKNESS

LIFETIME  
GUARANTEE

HydraSEAL

EASY-FIT

**Single Curved**

Size	Code	Panel	Product Adjustment	Price £ Exc. VAT	Price £ Inc. VAT
800 x 1500	MB1	1	780-800	218.27	261.92

**Single Curved - Easy-Fit Bundle**

800 x 1500	MB1FLEX	1	780-800	279.31	335.17
------------	---------	---	---------	--------	--------

*Features*

- » Frameless curved screen
- » 6mm toughened safety glass
- » Reversible
- » Lifetime guarantee
- » Door swing - 90 degrees in and out

**MB2**  
Bathscreen

SCAN FOR MORE INFORMATION

1500 MM  
HEIGHT  
STANDARD RANGE

6 MM  
GLASS  
THICKNESS

LIFETIME  
GUARANTEE

MERSHIELD STAYCLEAR

HydraSEAL

EASY-FIT

**Single Square**

Size	Code	Panel	Product Adjustment	Price £ Exc. VAT	Price £ Inc. VAT
800 x 1500	MB2	1	780-800	258.20	309.85

**Single Square - Easy-Fit Bundle**

800 x 1500	MB2FLEX	1	780-800	317.67	381.20
------------	---------	---	---------	--------	--------

*Features*

- » Frameless screen
- » 6mm toughened safety glass
- » Mershield Stayclear™
- » Reversible
- » Lifetime guarantee
- » Door swing - 90 degrees in and out

**MB2**  
Bathscreen

SCAN FOR MORE INFORMATION

1500 MM  
HEIGHT  
STANDARD RANGE

6 MM  
GLASS  
THICKNESS

LIFETIME  
GUARANTEE

MERSHIELD STAYCLEAR

HydraSEAL

**Single Square With Towel Rail**

Size	Code	Panel	Product Adjustment	Price £ Exc. VAT	Price £ Inc. VAT
800 x 1500	MB2T	1	780-800	324.30	389.16

*Features*

- » Frameless 6mm toughened safety glass
- » Mershield Stayclear™
- » Includes towel rail
- » HydraSeal sealant
- » Reversible
- » Lifetime guarantee
- » Door swing - 90 degrees in and out



**MB3a**  
Bathscreen

SCAN FOR MORE INFORMATION

1500 MM HEIGHT (SCREEN RANGE)  
6 MM GLASS THICKNESS  
LIFETIME GUARANTEE

HydraSEAL  
EASY-FIT

### 2 Panel Folding Curved

Size	Code	Panel	Product Adjustment	Price £ Exc. VAT	Price £ Inc. VAT
900 x 1500	MB3A	2	880 - 900	360.68	432.82

### 2 Panel Folding Curved - EASY-FIT BUNDLE

900 x 1500	MB3AFLEX	2	880 - 900	416.18	499.42
------------	----------	---	-----------	--------	--------

#### Features

- » Frameless screen
- » 6mm toughened safety glass
- » Reversible
- » Lifetime guarantee
- » Door swing - 90 degrees in and out

**MB3b**  
Bathscreen

SCAN FOR MORE INFORMATION

1500 MM HEIGHT (SCREEN RANGE)  
6 MM GLASS THICKNESS  
LIFETIME GUARANTEE

HydraSEAL  
EASY-FIT

### 2 Panel Square

Size	Code	Panel	Product Adjustment	Price £ Exc. VAT	Price £ Inc. VAT
900 x 1500	MB3B	2	880 - 900	360.68	432.82

### 2 Panel Square - EASY-FIT BUNDLE

900 x 1500	MB3BFLEX	2	880 - 900	416.18	499.42
------------	----------	---	-----------	--------	--------

#### Features

- » Frameless screen
- » 6mm toughened safety glass
- » Reversible
- » Lifetime guarantee
- » Door swing - 90 degrees in and out

**MB3c**  
Bathscreen

SCAN FOR MORE INFORMATION

1500 MM HEIGHT (SCREEN RANGE)  
6 MM GLASS THICKNESS  
LIFETIME GUARANTEE

HydraSEAL  
EASY-FIT

### 2 Panel Curved

Size	Code	Panel	Product Adjustment	Price £ Exc. VAT	Price £ Inc. VAT
900 x 1500	MB3C	2	880 - 900	360.68	432.82

### 2 Panel Curved - EASY-FIT BUNDLE

900 x 1500	MB3CFLEX	2	880 - 900	416.18	499.42
------------	----------	---	-----------	--------	--------

#### Features

- » Frameless 6mm toughened safety glass
- » HydraSeal sealant
- » Reversible
- » Lifetime guarantee
- » Door swing - 90 degrees in and out

**MB4**  
Bathscreen

SCAN FOR MORE INFORMATION

1400 MM HEIGHT (SCREEN RANGE)  
4 MM GLASS THICKNESS  
LIFETIME GUARANTEE  
MERSHIELD STAYCLEAR™

### 4 Fold

Size	Code	Panel	Product Adjustment	Price £ Exc. VAT	Price £ Inc. VAT
850 x 1400	MB4	4	845 - 850	428.47	514.16

#### Features

- » 4mm toughened safety glass
- » Mersfield Stayclear™
- » Reversible
- » Easy storage
- » Lifetime guarantee

**MB13**  
Bathscreen

SCAN FOR MORE INFORMATION

1500 MM HEIGHT (SCREEN RANGE)  
6 MM GLASS THICKNESS  
LIFETIME GUARANTEE  
MERSHIELD STAYCLEAR™

### 2 Panel Folding

Size	Code	Panel	Product Adjustment	Price £ Exc. VAT	Price £ Inc. VAT
1100 x 1500	MB13	2	1080 - 1100	565.03	678.03

#### Features

- » Frameless 6mm toughened safety glass
- » Mersfield Stayclear™
- » Reversible
- » Lifetime guarantee
- » Door Swing: 180 degree radius of screen swing inwards and outwards

# INTRODUCING MB14 & MB14F in Colour

**Matt  
Black**



**Brushed  
Brass**



**Brushed  
Bronze**



**MB14**  
Bathscreen

SCAN FOR MORE INFORMATION

1500 MM HEIGHT STANDARD RANGE  
8 MM GLASS THICKNESS  
LIFETIME GUARANTEE  
MERSHIELD STAYCLEAR  
ECO FRIENDLY PACKAGING  
EASY CLEAN GLASS

*Brushed Brass*

## MERLYN Fixed Square

Size	Code	Colour Code	Panel	Product Adjustment	Price £ Exc. VAT	Price £ Inc. VAT
800 x 1500	MB14	Chrome only code	1	785-800	281.80	338.16
800 x 1500	MB14	add <b>MB</b> / <b>BBR</b> or <b>BBZ</b>	1	785-800	266.67	320.00

### Features

- » 8mm toughened glass
- » Anodised aluminium finish - more durable than powder coating
- » Reversible
- » 4 Colour finishes
- » Lifetime Guarantee
- » Minimalist frameless design

When ordering your bath screen please add the desired colour code to the end of the standard chrome code.

**Example:** MB14 is the standard chrome code add **MB** for Matt Black, **BBR** for Brushed Brass or **BBZ** for Brushed Bronze.

**E.G. MB14MB = MB14 Matt Black.**

**MB14F**  
Bathscreen

SCAN FOR MORE INFORMATION

1500 MM HEIGHT STANDARD RANGE  
8 MM GLASS THICKNESS  
LIFETIME GUARANTEE  
MERSHIELD STAYCLEAR  
ECO FRIENDLY PACKAGING  
EASY CLEAN GLASS

*Brushed Bronze*

## MERLYN Fixed Framed

Size	Code	Colour Code	Panel	Product Adjustment	Price £ Exc. VAT	Price £ Inc. VAT
800 x 1500	MB14F	add <b>MB</b> / <b>BBR</b> or <b>BBZ</b>	1	775-790	366.67	440.00

Not available in chrome

### Features

- » 8mm toughened glass
- » Anodised aluminium finish - more durable than powder coating
- » Reversible
- » Fully framed design
- » Lifetime Guarantee
- » 3 Colour finishes

When ordering your bath screen please add the desired colour code to the end of the standard chrome code.

**Example:** MB14F is the standard chrome code add **MB** for Matt Black, **BBR** for Brushed Brass or **BBZ** for Brushed Bronze.

**E.G. MB14MB = MB14F Matt Black.**





*Touchstone Tray*

*Design details*



Graduated adjustable leg and easy-fit tray panel kit.



Adjustable leg system.



90mm fast flow waste, includes hair trap and chrome cover.



\*Quadrant tray is handed – please choose L for Left Hand and R for Right Hand when ordering.





10 YEARS  
GUARANTEE

# TOUCHSTONE

Beautifully sculpted shower trays, angled and contoured to match enclosures and spaces, achieving the perfect combination of luxury, elegance and durability.

## features

- » 10 Year Guarantee
- » 50mm high to achieve minimalist design
- » Available as low level or with tray panel kits for easy installation
- » Compatible 90mm fast flow waste also available
- » More than 30 sizes available

### Rectangular & Square Trays (Waste sold separately)

Size	Code	Tray Panel Kit	Price £ Exc. VAT	Price £ Inc. VAT
700 x 700	S70SQTO	Kit 4	110.29	132.35 NEW
760 x 760	S76SQTO	Kit 4	115.63	138.76
800 x 800	S80SQTO	Kit 4	129.57	155.48
900 x 900	S90SQTO	Kit 4	149.64	179.56
800 x 700	S870RTTO	Kit 4	174.01	208.81
800 x 760	S876RTTO	Kit 4	174.01	208.81
900 x 700	S970RTTO	Kit 4	190.15	228.18
900 x 760	S976RTTO	Kit 4	190.15	228.18
900 x 800	S980RTTO	Kit 4	190.15	228.18
1000 x 700	S107RTTO	Kit 4	196.35	235.62
1000 x 760	S1076RTTO	Kit 4	196.35	235.62
1000 x 800	S108RTTO	Kit 4	196.35	235.62
1000 x 900	S109RTTO	Kit 4	203.89	244.66
1100 x 760	S1176RTTO	Kit 4	203.89	244.67 NEW
1100 x 800	S118RTTO	Kit 4	203.89	244.66
1100 x 900	S119RTTO	Kit 4	203.89	244.67 NEW
1200 x 700	S127RTTO	Kit 4	203.89	244.66
1200 x 760	S1276RTTO	Kit 4	213.61	256.33
1200 x 800	S128RTTO	Kit 4	226.42	271.70
1200 x 900	S129RTTO	Kit 4	243.00	291.60
1300 x 800	S138RTTO	Kit 3	315.39	378.47
1300 x 900	S139RTTO	Kit 3	315.39	378.47 NEW
1400 x 700	S147RTTO	Kit 3	324.85	389.82
1400 x 760	S1476RTTO	Kit 3	324.85	389.82
1400 x 800	S148RTTO	Kit 3	324.85	389.82
1400 x 900	S149RTTO	Kit 3	342.37	410.85
1500 x 700	S157RTTO	Kit 3	360.95	433.14
1500 x 760	S1576RTTO	Kit 3	381.12	457.34
1500 x 800	S158RTTO	Kit 3	381.12	457.34
1500 x 900	S159RTTO	Kit 3	401.17	481.40
1600 x 700	S167RTTO	Kit 3	425.28	510.34
1600 x 760	S1676RTTO	Kit 3	425.28	510.34 NEW
1600 x 800	S168RTTO	Kit 3	425.28	510.34
1600 x 900	S169RTTO	Kit 3	446.53	535.84
1685 x 700	S177RTTO	Kit 3	460.70	552.85
1680 x 760	S1776RTTO	Kit 3	474.88	569.85
1700 x 800*	S178RTTO	Kit 3	516.70	620.04
1700 x 900*	S179RTTO	Kit 3	556.56	667.87
1800 x 700*	S187RTTO	Kit 3	590.24	708.29 NEW
1800 x 800*	S188RTTO	Kit 3	630.31	756.38
1800 x 900*	S189RTTO	Kit 3	660.87	793.04 NEW

\*Waste is centred on 1700x800 - 1800x900 trays. See Page 157 for Tray Panel Kit Information.

### Quadrant Tray (Waste sold separately)

Size	Code	Tray Panel Kit	Price £ Exc. VAT	Price £ Inc. VAT
800 x 800	S80QTO	Kit 2	141.76	170.12
900 x 900	S90QTO	Kit 2	158.45	190.14
1000 x 1000	S100QTO	Kit 2	180.24	216.29 NEW

### Offset Quadrant Tray (Waste sold separately)

*900x760 LH	S976QLTO	Kit 1	190.32	228.38 NEW
*900x760 RH	S976QRTO	Kit 1	190.32	228.38 NEW
*1000 x 800 LH	S108QLTO	Kit 1	215.08	258.10
*1000 x 800 RH	S108QRTO	Kit 1	215.08	258.10
*1200 x 800 LH	S128QLTO	Kit 1	226.42	271.70
*1200 x 800 RH	S128QRTO	Kit 1	226.42	271.70
*1200 x 900 LH	S129QLTO	Kit 1	267.16	320.59
*1200 x 900 RH	S129QRTO	Kit 1	267.16	320.59

This product is handed – please choose L for Left Hand and R for Right Hand when ordering. White Waste Cap is for Touchstone trays only. Waste cap comes in chrome as standard.

### Tray Accessories

	Code	Price £ Exc. VAT	Price £ Inc. VAT
White Waste Cap	DWASCAPWHT	17.12	20.54
Complete Waste	DWAS	39.06	46.87



SCAN FOR MORE  
INFORMATION



*Touchstone-SR Tray*

*Design details*



Graduated adjustable leg and easy-fit tray panel kit.



Adjustable leg system.



90mm fast flow waste, includes hair trap and chrome cover.



\*Quadrant tray is handed – please choose L for Left Hand and R for Right Hand when ordering.





# TOUCHSTONE-SR

We have carried out all the testing to give you and your family the peace of mind of showering in a safe environment and the splendour of this natural stone effect.

## features

- » 10 Year Guarantee
- » 50mm high to achieve minimalist design
- » Available as low level or with tray panel kits for easy installation
- » Slip-resistant is manufactured into the coating and won't wear
- » Compatible 90mm fast flow waste also available
- » More than 30 sizes available

### Rectangular & Square Trays (Waste sold separately)

Size	Code	Tray Panel Kit	Price £ Exc. VAT	Price £ Inc. VAT
800 x 800	S80SQASTO	Kit 4	171.54	205.85
900 x 900	S90SQASTO	Kit 4	198.12	237.75
900 x 800	S98RTASTO	Kit 4	251.75	302.10
1000 x 800	S108RTASTO	Kit 4	259.98	311.98
1000 x 900	S109RTASTO	Kit 4	269.95	323.94
1100 x 800	S118RTASTO	Kit 4	269.95	323.94
1200 x 700	S127RTASTO	Kit 4	269.95	323.94
1200 x 760	S1276RTASTO	Kit 4	282.83	339.39
1200 x 800	S128RTASTO	Kit 4	299.80	359.76
1200 x 900	S129RTASTO	Kit 4	321.77	386.12
1400 x 700	S147RTASTO	Kit 3	430.11	516.13
1400 x 800	S148RTASTO	Kit 3	430.11	516.13
1400 x 900	S149RTASTO	Kit 3	453.34	544.01
1500 x 760	S1576RTASTO	Kit 3	504.64	605.56
1500 x 800	S158RTASTO	Kit 3	504.64	605.56
1500 x 900	S159RTASTO	Kit 3	531.18	637.42
1600 x 700	S167RTASTO	Kit 3	563.10	675.72
1600 x 800	S168RTASTO	Kit 3	563.10	675.72
1600 x 900	S169RTASTO	Kit 3	591.24	709.49
1685 x 700	S177RTASTO	Kit 3	610.00	732.00
1700 x 800	S178RTASTO	Kit 3	684.16	820.99
1700 x 900	S179RTASTO	Kit 3	736.94	884.32

\*Waste is centred on 1700x800 & 1700x900 trays.

### Quadrant Tray (Waste sold separately)

Size	Code	Tray Panel Kit	Price £ Exc. VAT	Price £ Inc. VAT
800 x 800	S80QASTO	Kit 2	187.66	225.19
900 x 900	S90QASTO	Kit 2	209.84	251.81
*1000 x 800	S108QLASTO LH	Kit 1	284.78	341.74
*1000 x 800	S108QRASTO RH	Kit 1	284.78	341.74
*1200 x 800	S128QLASTO LH	Kit 1	299.80	359.76
*1200 x 800	S128QRASTO RH	Kit 1	299.80	359.76
*1200 x 900	S129QLASTO LH	Kit 1	353.75	424.50
*1200 x 900	S129QRASTO RH	Kit 1	353.75	424.50

This product is handed – please choose L for Left Hand and R for Right Hand when ordering.

### Tray Panel Kit

Tray Panel Kit	Code	Price £ Exc. VAT	Price £ Inc. VAT
Kit 1	DRK1	131.96	158.35
Kit 2	DRK2	131.96	158.35
Kit 3	DRK3	131.96	158.35
Kit 4	DRK4	131.96	158.35

### Tray Accessories

	Code	Price £ Exc. VAT	Price £ Inc. VAT
White Waste Cap	DWASCAPWHT	17.12	20.54
Complete Waste	DWAS	39.06	46.87



SCAN FOR MORE INFORMATION



# Tray Waste Positions

## Touchstone Trays

Shape	Size	Waste Position A, mm	Waste Position B, mm
<b>Square</b>		<b>A</b>	<b>B</b>
	760	148	148
	800	148	148
	900	148	148

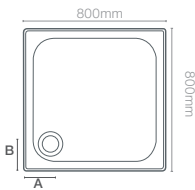

Rectangle	A	B
	800 x 700	148 148
	800 x 760	148 148
	900 x 700	148 148
	900 x 760	148 148
	900 x 800	148 148
	1000 x 700	148 148
	1000 x 760	148 148
	1000 x 800	148 148
	1000 x 900	148 148
	1100 x 760	148 148
	1100 x 800	148 148
	1100 x 900	148 148
	1200 x 700	148 148
	1200 x 760	148 148
	1200 x 800	148 148
	1200 x 900	148 148
	1300 x 800	148 148
	1300 x 900	148 148
	1400 x 700	148 148
	1400 x 760	148 148
	1400 x 800	148 148
	1400 x 900	148 148
	1500 x 700	148 148
	1500 x 760	148 148
	1500 x 800	148 148
	1500 x 900	148 148
	1600 x 700	148 148
	1600 x 760	148 148
	1600 x 800	148 148
	1600 x 900	148 148
	1685 x 700	148 148
	1680 x 760	148 148
	1600 x 900	148 148
	1685 x 700	148 148
	1700 x 800	130 850
	1700 x 900	130 850
	1800 x 760	130 900
	1800 x 800	130 900
	1800 x 900	130 900

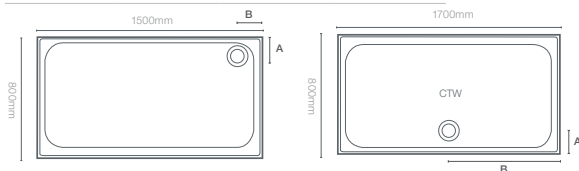

Waste is centred for 1700 x 800 / 1700 x 900 / 1800 x 700 / 1800 x 800 & 1800 x 900 trays

## Touchstone Trays - Continued

Shape	Size	Waste Position A, mm	Waste Position B, mm
<b>Quad</b>		<b>A</b>	<b>B</b>
	800	250	130
	900	350	130

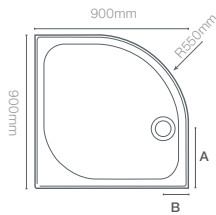

Offset Quad	A	B
	1000 x 800	350 130
	1200 x 800	450 130
	1200 x 900	450 130

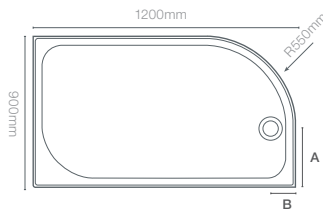

Left Handed (L) Right Handed (R)



Product is handed. Please choose L for Left or R for Right when ordering

# Product Information

We have produced this product section to help you with your purchasing decision. For further information please contact your local stockist, details of which can be found at [www.merlynshowering.com](http://www.merlynshowering.com)

## Product information

All products are manufactured in accordance with EN14428 and utilise toughened safety glass to EN 12150.

All shower trays are manufactured in accordance with EN14527.

All doors feature adjustable wall profiles to compensate for out-of-true walls and have micro adjustment features for fine tuning to obtain a perfect fit and operating action.

All enclosures, wetrooms and panels are Power Shower approved – will retain water under normal showering conditions.

Water retention is maintained in all products under normal showering conditions.

A selection of MERLYN enclosures are frameless in design. Spray/mist may escape therefore we would recommend use of these enclosures with tiled floors.

Opened cartons can not be returned. Returns carry a £40 box charge or £60 per unit where the sale is less than 30 days old. Returns over 30 days old will not be accepted.

All products are supplied complete with full installation instructions and the necessary fixings.

Check with your dealer for accurate matching of material samples. Product descriptions do not imply the use of precious or valuable materials.

Our policy of reviewing product design and development on a regular basis means MERLYN reserve the right to change product specifications and prices without notice.

Only shower enclosures, panels, Truestone shower trays and bath screens are covered by the Lifetime Guarantee. Please contact the MERLYN sales team for more details.

Glass shattering and parts subject to wear are not covered by the Lifetime Guarantee.

For full details on all product ranges please contact MERLYN Showering on 0808 1011429 or log onto [www.merlynshowering.com](http://www.merlynshowering.com).

Trays shown in this catalogue are for illustrative purposes only.

## Images are for illustration purposes only.

The colours and finishes shown in the catalogue are as accurate as possible within the limits of the printing process. The positioning of all showering heads in the brochure is for illustrative purposes only.

All descriptions, specifications and particulars contained in this brochure are intended merely to represent a general idea of the products described herein and none of these form part of any contract to give rise to any independent or collateral liability upon the company.

## Cleaning

- » It is important to clean your MERLYN shower door and tray after every use. Wipe down all the glass and metal parts with a soft cloth.
- » Do not allow lime scale to build up in hard water areas.
- » Ensure that any residual water on the glass is removed after every use.
- » Clean the glass regularly using soapy water.
- » Do not use abrasive products on any surfaces.
- » Install the enclosure in a well ventilated area.

## Information and maintenance

Always read the instructions on the packaging, chrome is vulnerable to acid attack and some strong household cleaners including strong disinfectants, denture cleaners, hair dyes, wine making chemicals and photographic chemicals may contain acid. These materials may have a varying effect on the surface from black spots/streaks (which cannot be removed) to pitting the surface. Contact with these materials should be avoided.

## Important shower tray information

It is up to the designer or installer to ensure that the tray and enclosure combination is arranged in such a way that water retention meets the customers needs.

- » The waste has the capacity to carry away 29L/Min. High powered systems may exceed this. Please check with the manufacturer.
- » Please ensure that the shower head is not positioned directly over the waste as this may restrict water flow rate.
- » Please ensure that the colour and size of shower tray are as per your order before installation.
- » You must inspect the product thoroughly before installation. Fitting the product is acceptance of quality.
- » The trays are handmade from natural material. Please allow for height variances due to manufacturing tolerances.
- » For open ended shower screens please consult your installer.
- » Shower trays must be fitted as per the fitting instruction. Deviation from the pre installation checks or fitting installation will void the guarantee.
- » When wet, the surface of the majority of shower trays will show an increase in the potential for slipping. This is particularly the case when soap, shampoo, bath oil etc. are used. It is important that designers, installers and users are aware of this.

## Important

Although shower door and enclosure sizes are related to tray sizes it is important to note that most shower trays are tiled down to the rim, often over an 'up-stand'. The finished installation space may be less than the nominal tray size. MERLYN shower units are made to suit this remaining space.

## Tray Finish min-max

The Tray Finish applies when fitting a door and a tray. These are the minimum and maximum dimensions that a shower door or enclosure will fit using standard wall profiles.

## Tray finish

### To find the correct Tray Finish dimension:

**In a recess:** Measure from the finished, tiled wall to the opposite finished, tiled wall.

**In a corner:** Measure from the finished, tiled wall to the edge of the tray.

**Note:** If the wall/walls are leaning in, this will further reduce your Tray Finish.

## Adjustment

This is the min and max adjustment of the actual enclosure. These are the adjustment dimensions of the actual door excluding the tray. Therefore, these are the dimensions to follow when installing an enclosure in a wetroom application without a tray.

The guide below may be helpful in taking measurements to determine the shower door or enclosure size required. Dimensions given in this publication are in millimetres, are approximate and may vary with adjustment. They are subject to change without notice.

Please note that when a tray is fitted it is essential that the tray is level before any doors or enclosures are fitted.

## Recess Location

Take the measurements after the tray is installed and the walls are tiled.

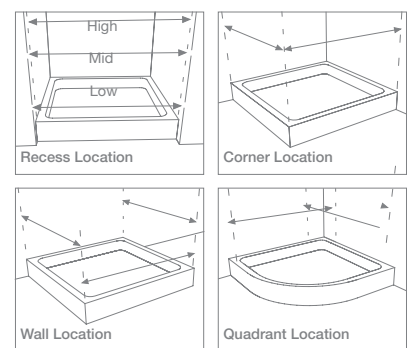

## Bath Screens

- » MERLYN Bath Screens are not designed to fit on baths with stepped fronts, roll top rims or integral soap dishes.
- » Fitting of screen on baths which have raised head rests or shapes is not recommended.
- » There must be no items causing obstruction with the seal and bath, as any of the above may cause leaks.
- » When choosing your Bath Screen, please ensure that if your bath has bath handles, they do not interfere with the bath rim area where your screen will be placed.
- » When choosing an in-swing or folding Bath Screen, please ensure your swing area is not interfering with any brassware or internal shower features. Similarly, when choosing an out-swing, please ensure the out-swing area is free from any obstructions.
- » It is recommended the shower head position is situated on the same wall to which the Bath Screen is fixed and in the centre of the shower area.

# MBOX Extension Profiles

Code	Price £ Ex. VAT	Price £ Inc. VAT
A0214B0	63.39	76.07

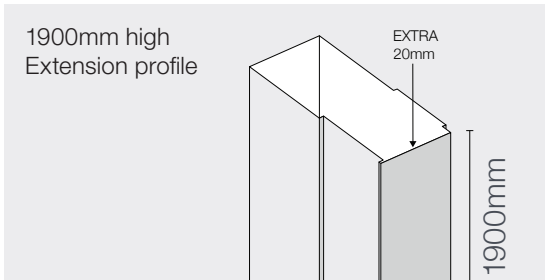

Code	Price £ Ex. VAT	Price £ Inc. VAT
MBEXT1800	59.16	70.99

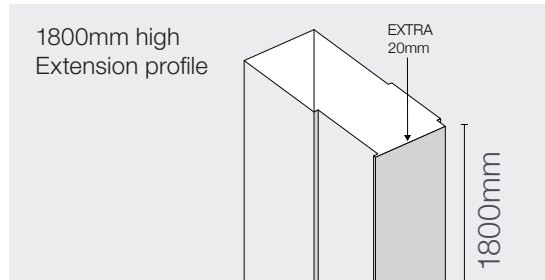

## UKCA, CE & EN Information

The UKCA (UK Conformity Assessment) mark on MERLYN enclosures is the new standard marking for products on the market in Great Britain (England, Wales and Scotland). It is a declaration that the product complies with GB designated standards.

The CE markings on MERLYN enclosures is a declaration that the product complies with the essential requirements of the relevant European health, safety and environmental protection legislation.

EU and GB legislation requires manufacturers to display either the UKCA mark for Great Britain and a CE mark for the EU and Northern Ireland on their product or packaging. It is an offence to place a product on the relevant market without a UKCA for Great Britain or CE marking for the EU market.

The manufacturer is legally responsible for ensuring that the product conforms to the requirements of both directives.

The European Commission thus refers to the CE marking as a "Passport" which allows products to be freely circulated within the EU single market. The UKCA marking allows products to move freely within Great Britain.

Often consumers will consider the UKCA and CE markings on a product as an indication of conformance to laid down minimum standards and therefore, a minimum level of safety which other products may lack. Both markings are often seen by consumers as a "Symbol of Safety."

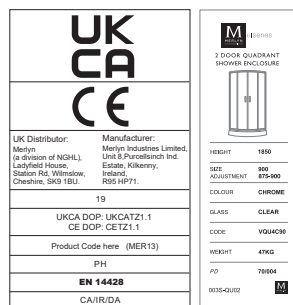

New GB, EU and NI label



MERLYN invests heavily in its product development and as such guarantees that its glass fully complies with regulations and is manufactured in accordance with BS EN 14428. The rigorous testing of the glass ensures that the endurance, stability and water retention criteria meet high industry standards.

## ISO Certification

MERLYN has implemented an Integrated Management System comprising of Quality Management, Environmental Management and Occupational Health and Safety Management. An Integrated Management System ensures the seamless integration of several different standards into a common system that meets the requirements of each of these standards. These certifications are proof of MERLYN's credibility but also to instil confidence in our potential consumers that MERLYN will keep its promises.







# MERLYN™

Unit 8, Purcellsinch Industrial Estate, Dublin Road, Kilkenny, Ireland, R95 HP71.

T 0808 1011 429 / F 0808 1011 428  
E sales@merlyn.ie / technical@merlyn.ie  
www.merlynshowering.com



## MBOX

SHOWER ENCLOSURES

